

LLC

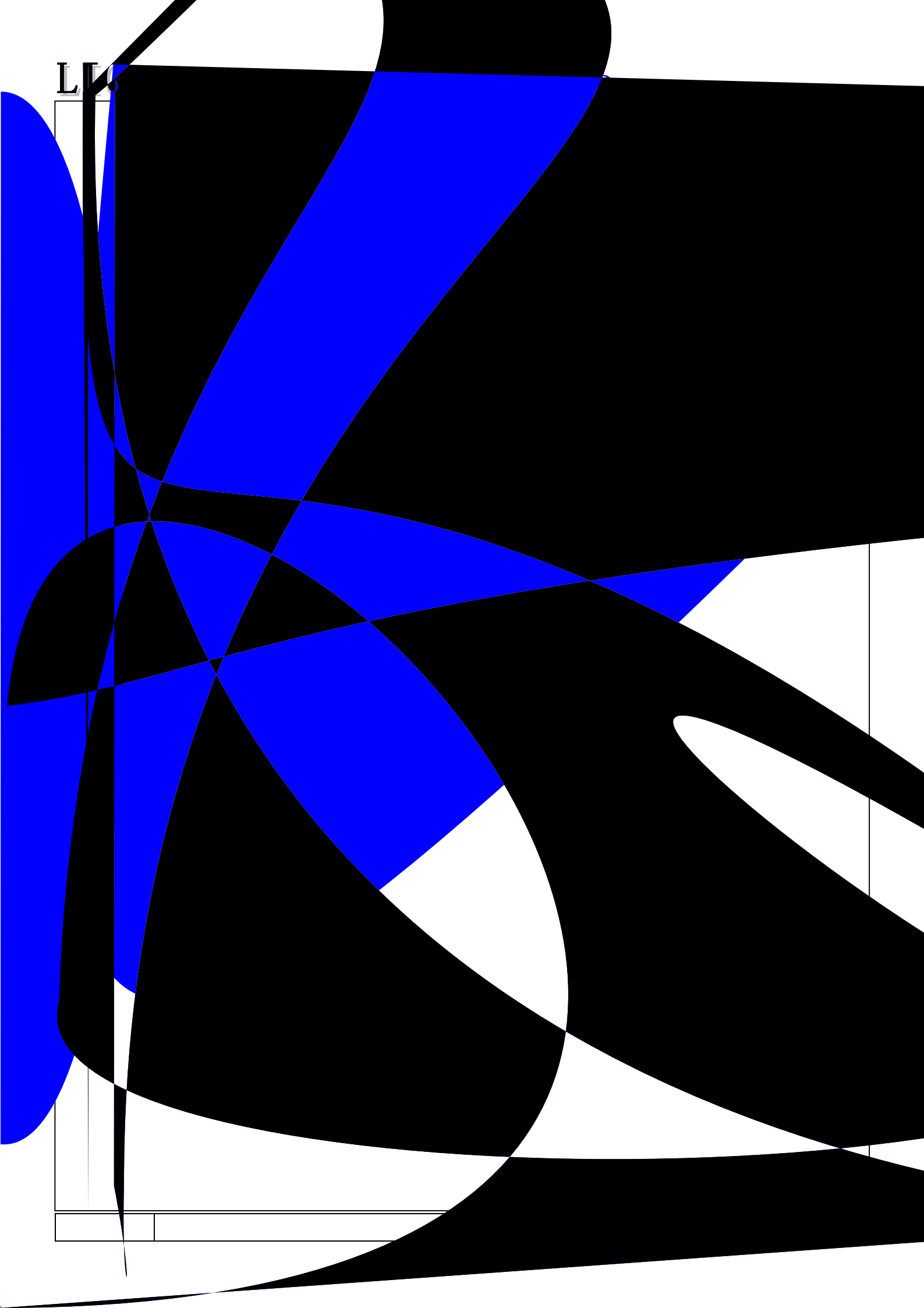

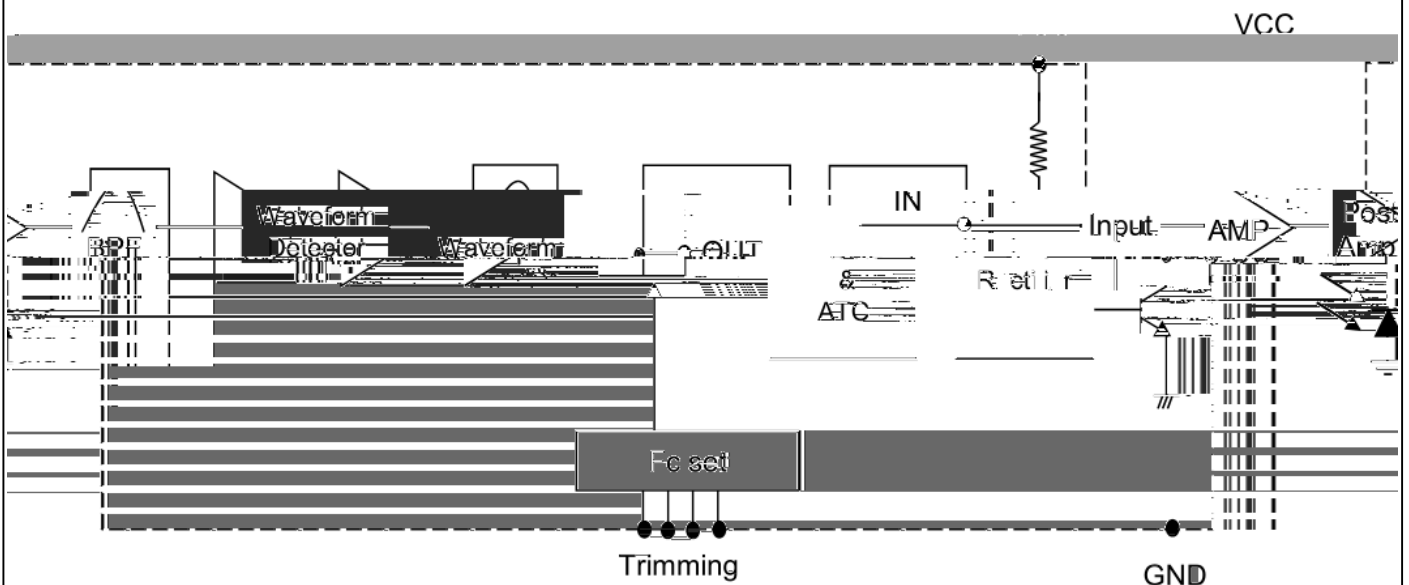

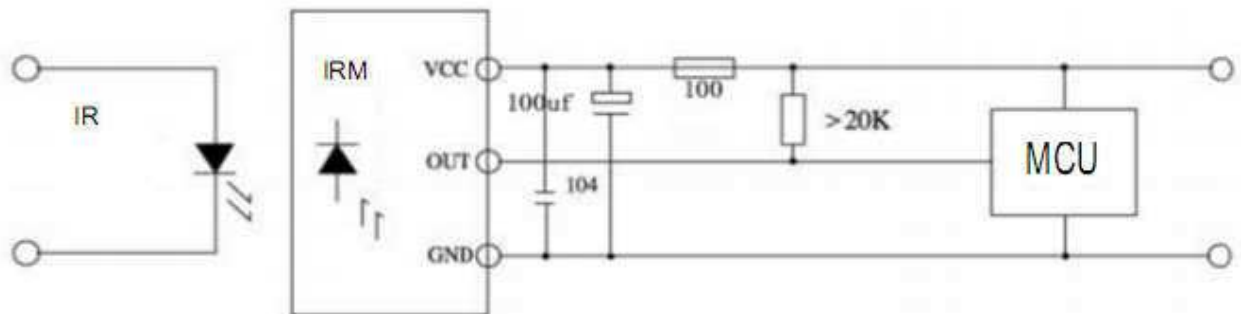
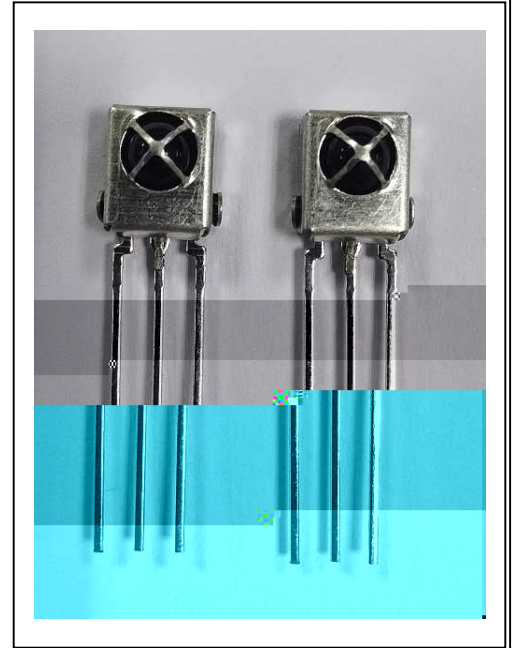
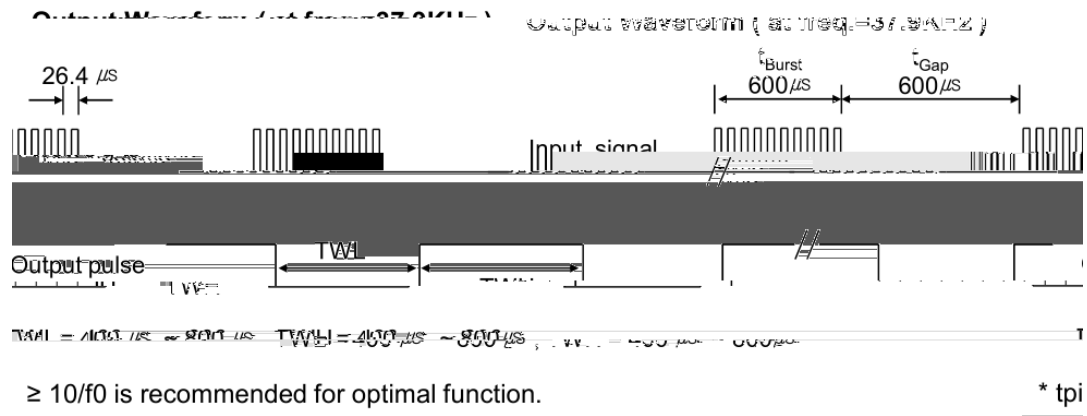

Minimum Burst Length t_{burst} (number of pulses per burst)	200us
Minimum Burst Gap time t_{burst_gap} (number of pulses per burst) between two burst	300us
Minimum pause time (for full frame repeat code)	< 1 ms

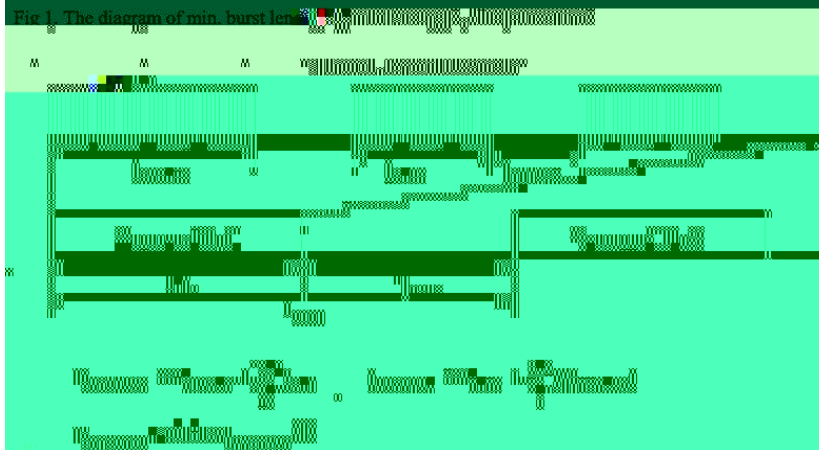

	1.5k ,			

LIGH

LIGHT ELECTRONICS CO., LTD.

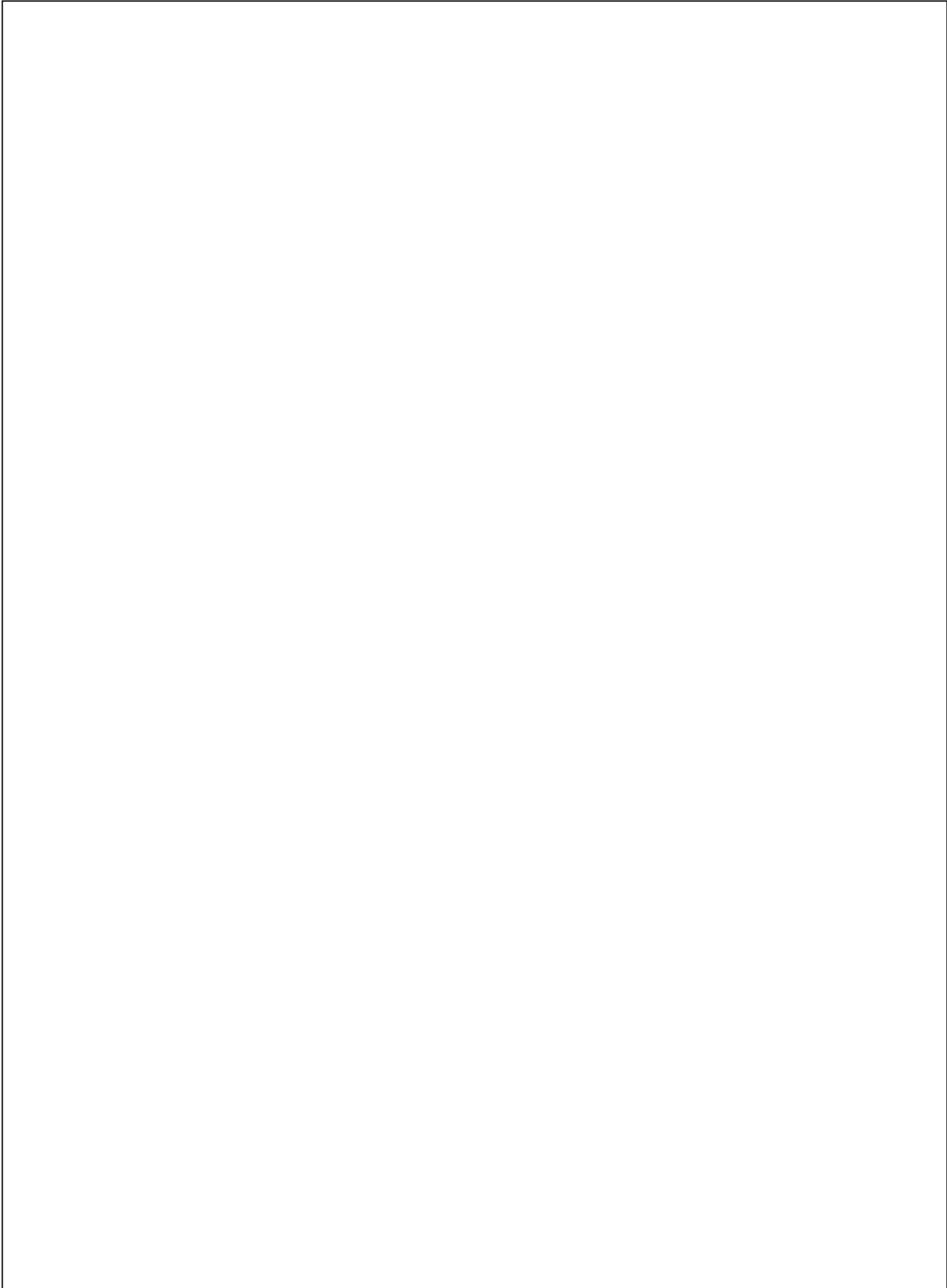

--	--	--	--

