

# LG-03PT4D94H-302C-B3

## PHOTO TRANSISTOR

### DATA SHEET

SPEC. NO. : SZ23022102  
DATE : 2023/02/21  
REV. : A/0

Approved By:

Checked By:

Prepared By:

## Features

- ◆ Pb free product    RoHS compliant
- ◆ High Photo Sensitivity
- ◆ General purpose leads
- ◆ Reliable and rugged
- ◆ Long life    solid state reliability

## Package Dimension

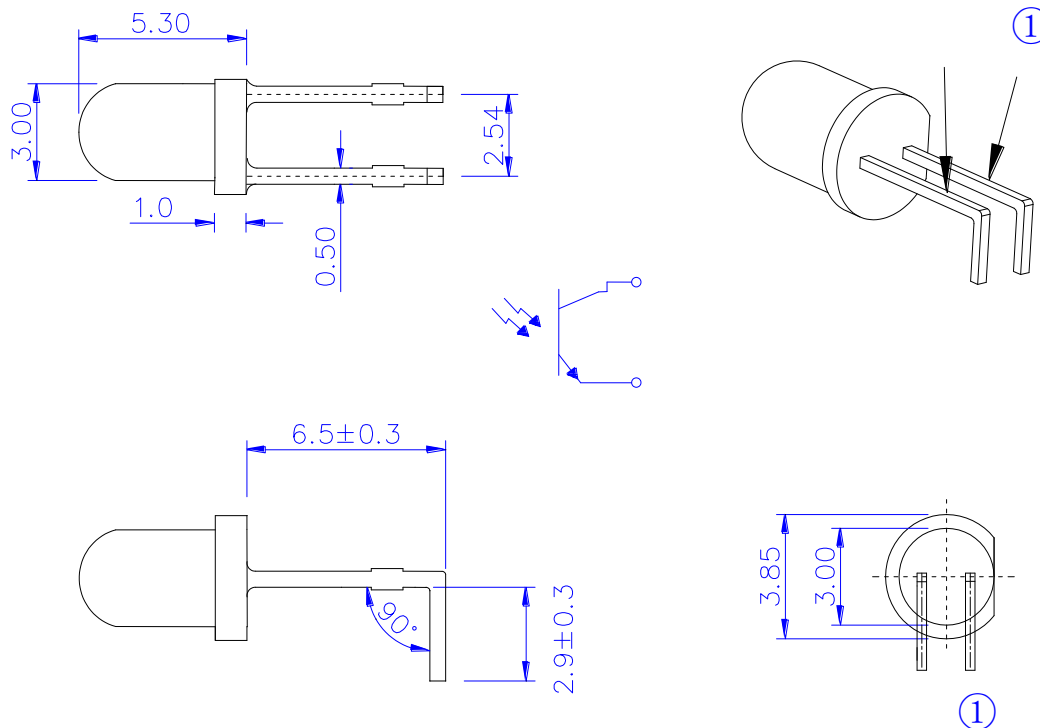

Part NO.	Chip Material	Lens Color
LG-03PT4D94H-302C-B3	Silicon	Black

### Notes:

1. All dimensions are in millimeters.
2. Tolerance is  $\pm 0.20$ mm unless otherwise noted.
3. Protruded resin under flange is 1.0mm max.
4. Lead spacing is measured where the leads emerge from the package.

## Absolute Maximum Ratings at Ta=25°C

### 1. Storage

The storage ambient for the LEDs should not exceed 30°C temperature or 70% relative humidity.

It is recommended that LEDs out of their original packaging are used within three months.

For extended storage out of their original packaging, it is recommended that the LEDs be stored in



## Recommended Wave Soldering Profile

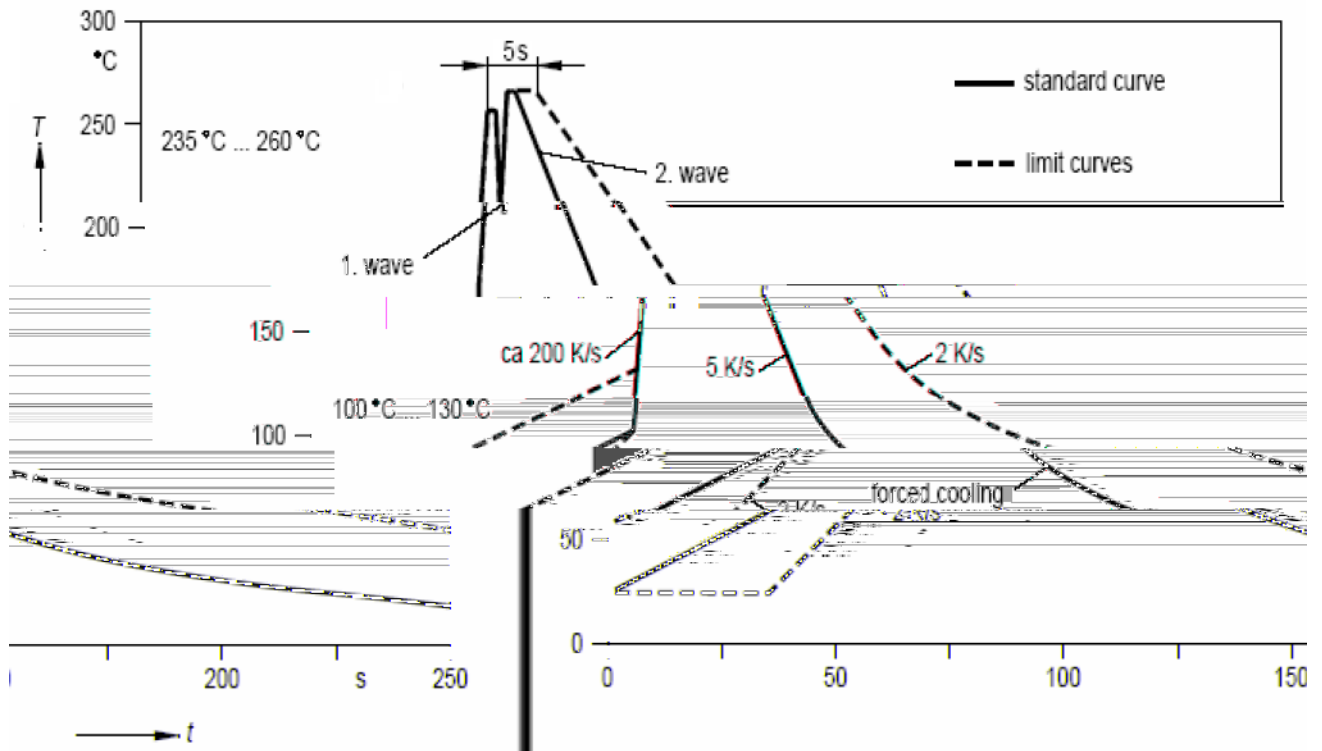

## Typical Electrical / Optical Characteristics Curves (25°C Ambient Temperature Unless Otherwise Noted)

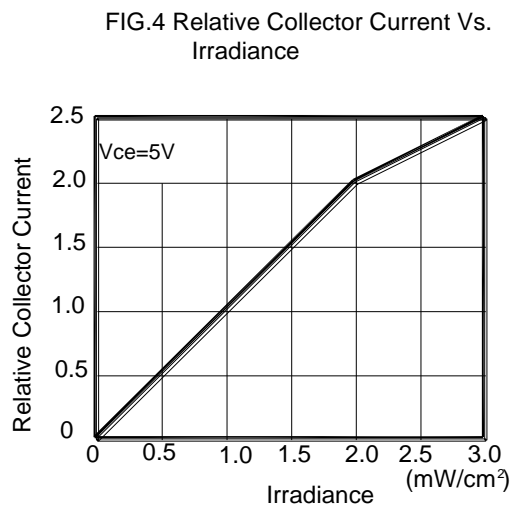
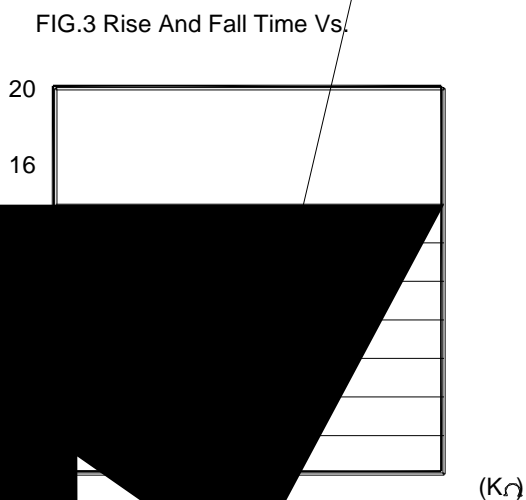
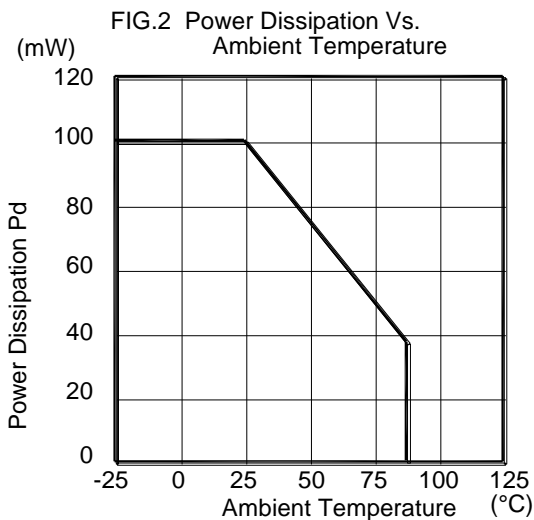
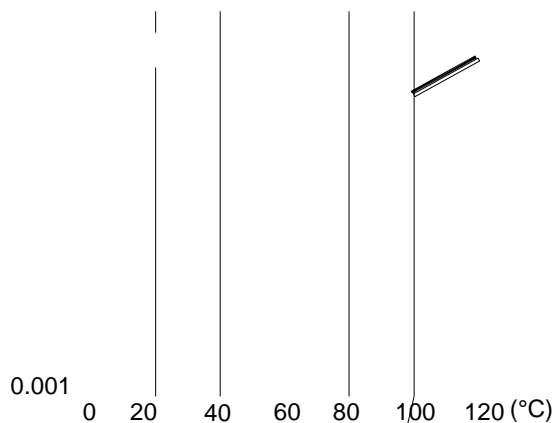

FIG.5 Light Current vs. Angular Displacement

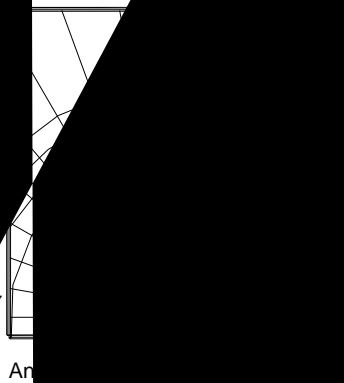
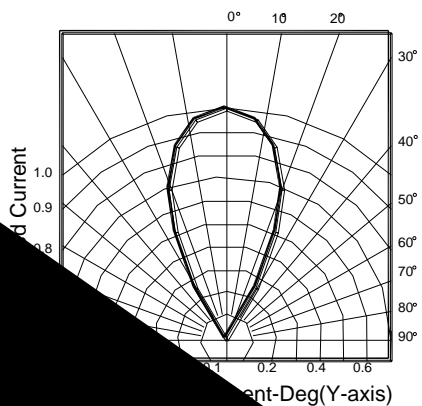

FIG.6 Light Current vs. Angular Displacement



LIG

## LEAD FORMING PROCEDURES

1. Maintain a minimum of 2mm clearance between the base of the LED lens and the first lead bend (Fig.5 and Fig.6).

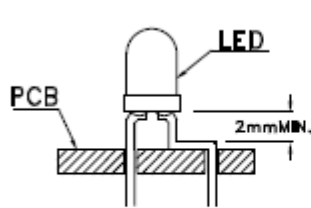

Fig. 5

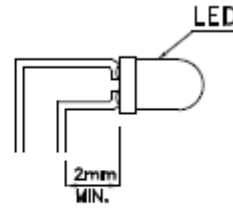

Fig. 6

2. Lead forming or bending must be performed before soldering, never during or after soldering.

3. Do not stress the LED lens during lead-forming in order to fractures in the lens epoxy and damage the internal structures.

4. During lead forming, use tools or jigs to hold the leads securely so that the bending force will not be transmitted to the LED lens and its internal structures. Do not perform lead forming once the component has been mounted onto the PCB (Fig.7).

5. Do not bend the leads more than twice (Fig.8).

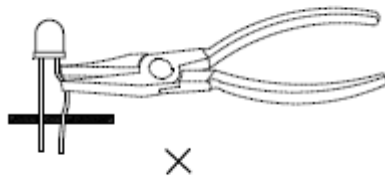

Fig. 7

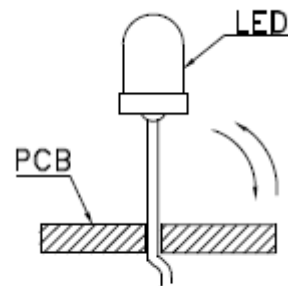

Fig. 8

6. After soldering or other high-temperature assembly, allow the LED to cool down to 50°C before applying outside force (Fig.9). In general, avoid placing excess force on the LED to avoid damage. For any questions please consult with LIGHT representative for proper handling procedures.

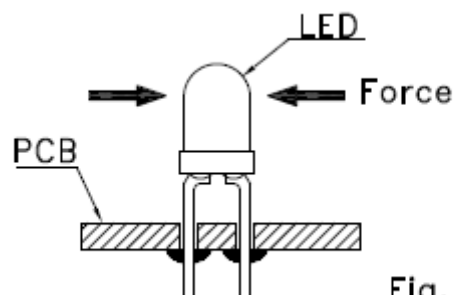
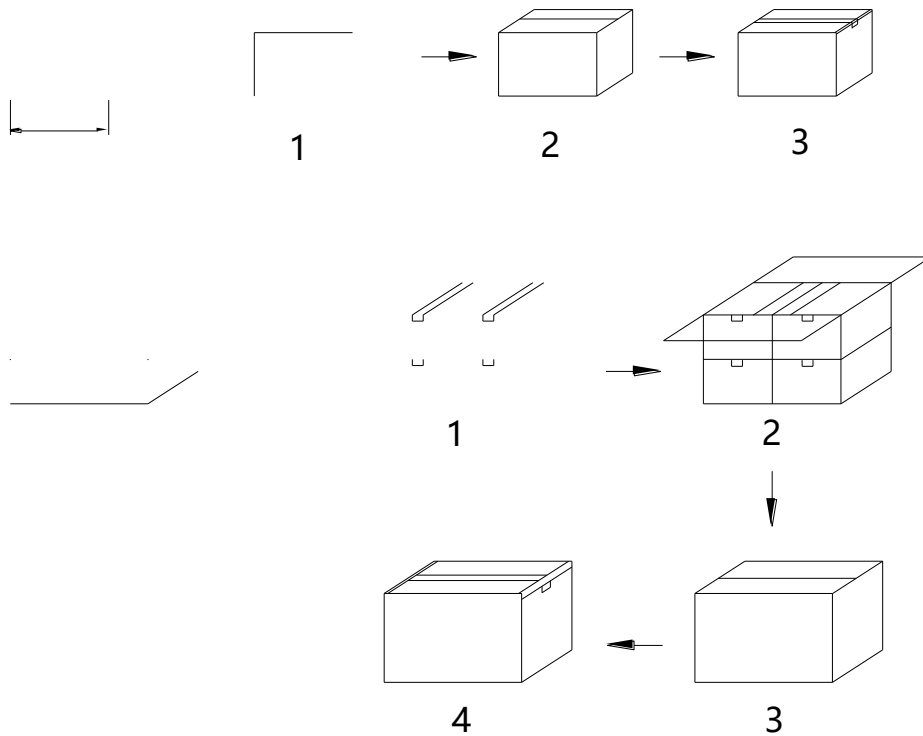
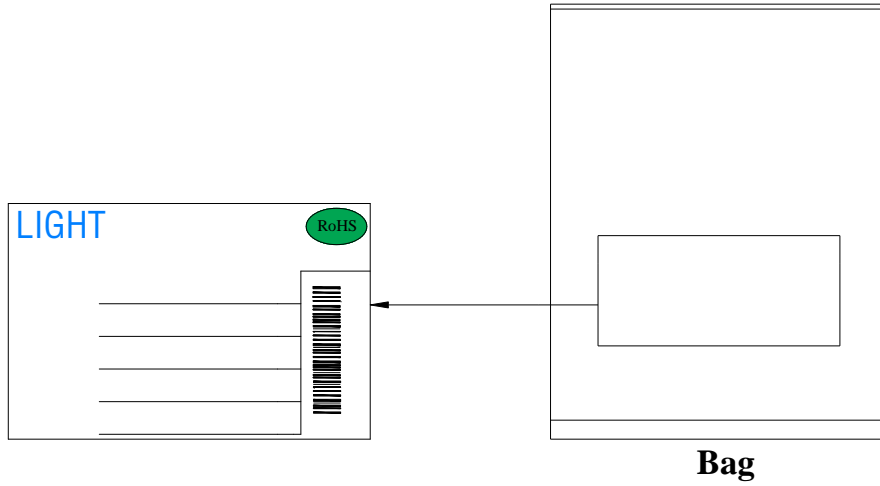

Fig. 9



## PACKAGE



Bag minimum volume (pcs / Bag)	Bag volume (pcs / Bag)	Inner box volume (Bag / box)	Outer carton volume (Box / Carton)
250	1000	10	4