







**LIGHT ELE**

## Typical Electrical / Optical Characteristics Curves (25 Ambient Temperature Unless Otherwise Noted)

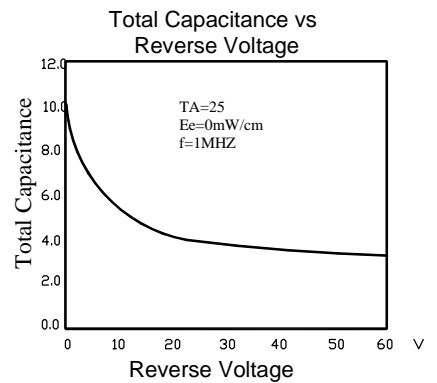
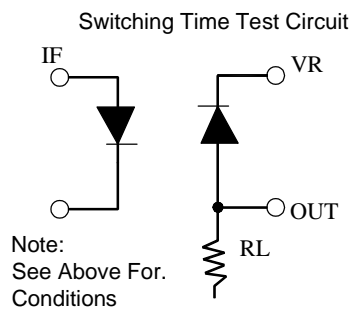
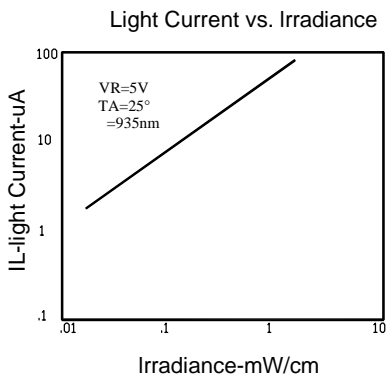
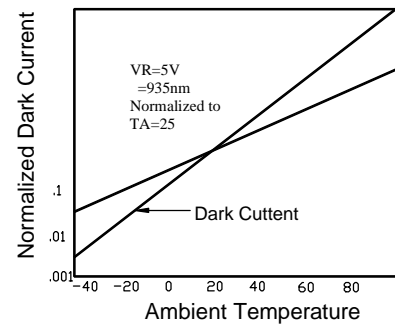
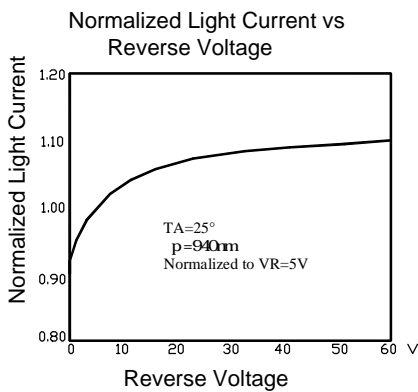
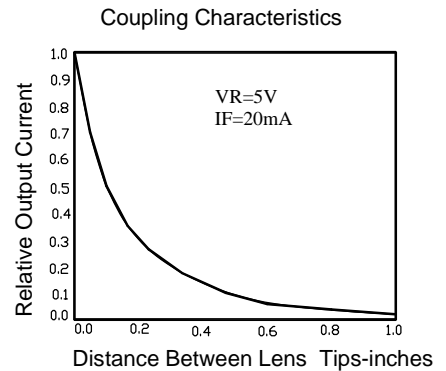
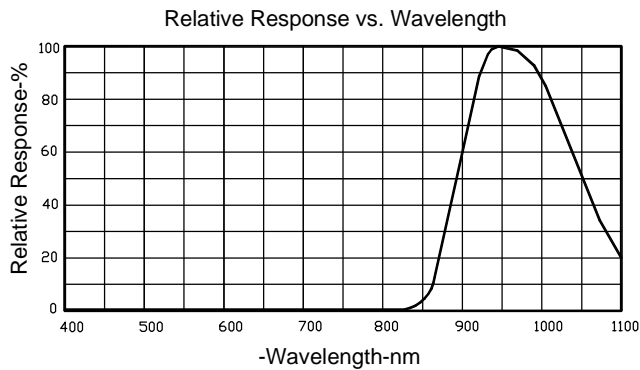





LIGHT

LIGHT ELECTRONIC

Part No. SL-T423



