

1.	3
2.	4
2.1	4
2.2	4
2.3	5
2.4		

LT986

LED

LT986

LED
LED

0.4ohm

--	--	--	--

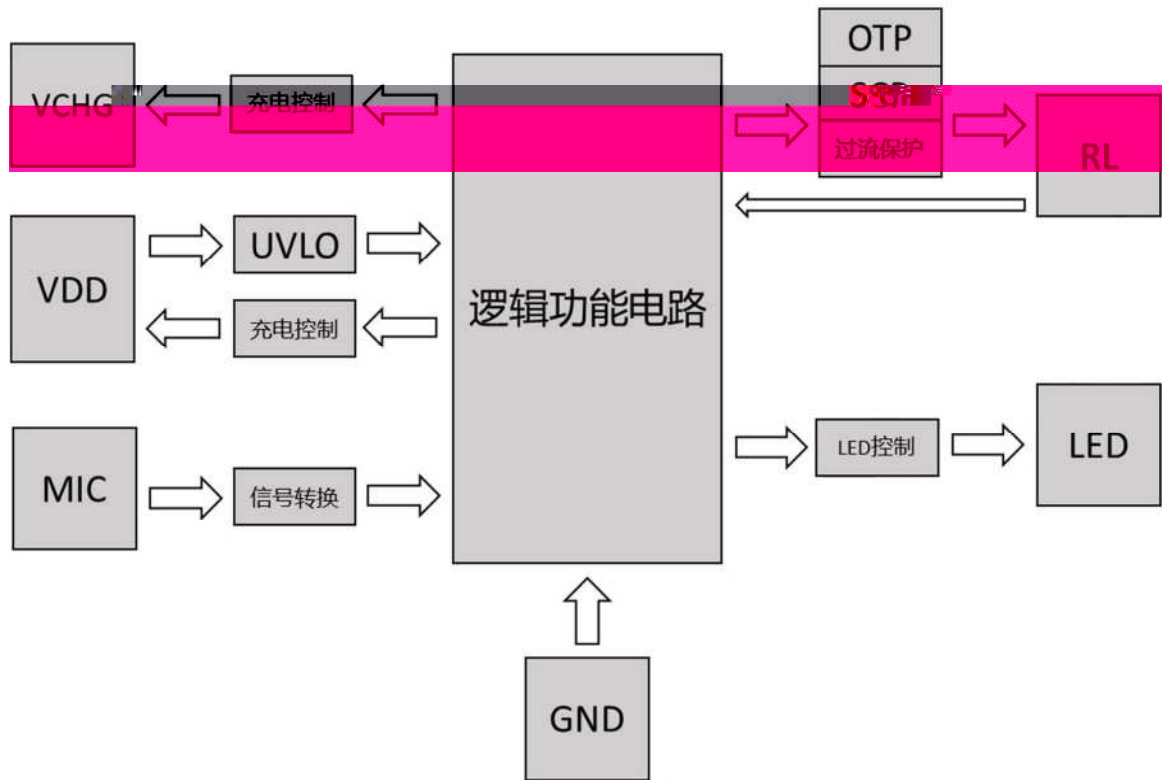

外形	序号	符号	功能描述
	1	VCHG	充电电源输入
	2	GND	地
	3	MIC	吸烟检测 (SENSOR)
	4	VOUT	接电热丝
	5	VDD	电源正极
	6	VDD	电源正极

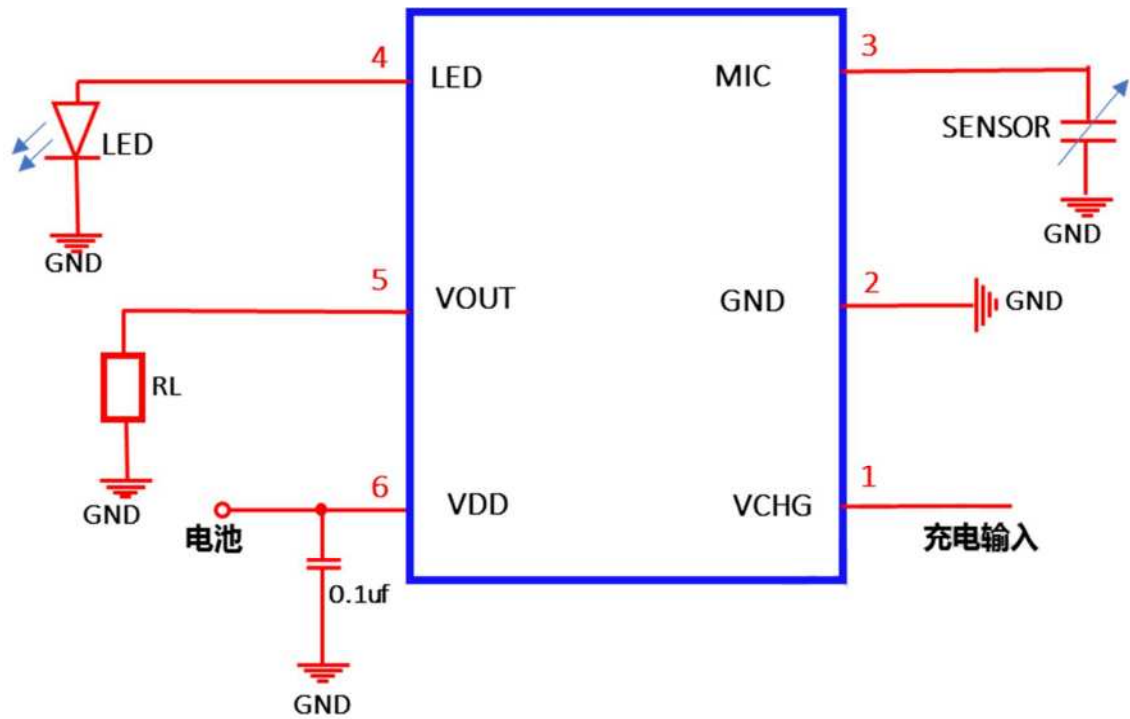

LED

LED
LED

AC-DC USB

2.7V

4.2V

2.7V

4.2V

--	--	--	--

33KHz

UVLO

3.3V UVLO

SCP

0.4 ohm

OTP

	1
/	/
	2
	2
	3
	3



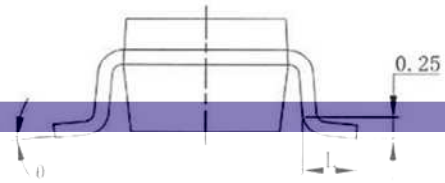
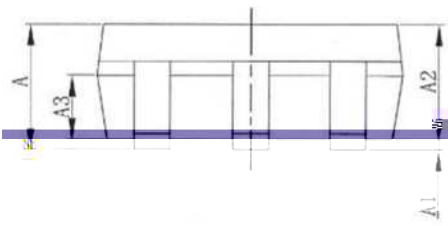

SYMBOL	MILLIMETER			
	MIN	NOM	MAX	
A	—	—	1.25	△
A1	0.04	—	0.10	△
A2	1.00	1.10	1.20	
A3	0.55	0.65	0.75	
b	0.38	—	0.48	
b1	0.37	0.40	0.43	
e	0.11	—	0.21	
e1	0.10	0.13	0.16	
D	2.72	2.92	3.12	
E	2.60	2.80	3.00	
E1	1.40	1.60	1.80	
e	0.95BSC			
e1	1.90BSC			
L	0.30	—	0.60	
θ	0	—	8°	

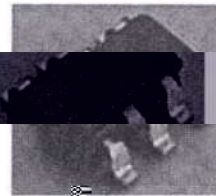
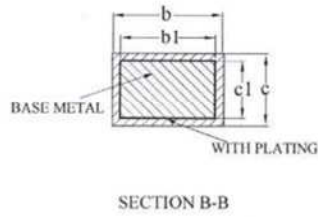
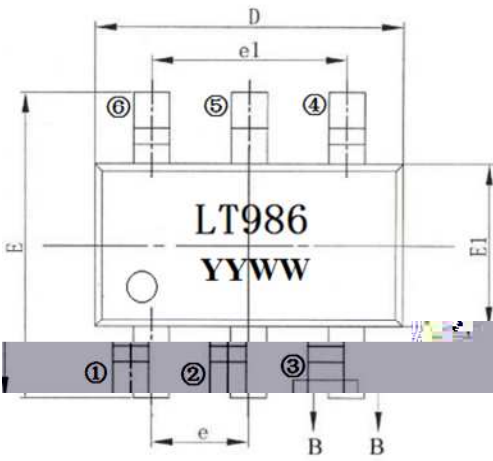

LT986
YYWW

2252

2022

52

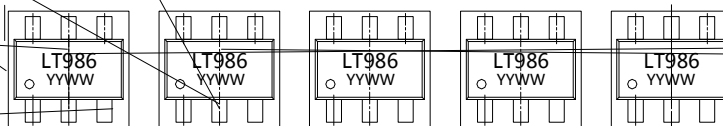

IR Reflow	Ta=245°C T=10 sec	3 times	22PCS	0/1
Temperature Cycling Test	-55°C 150°C 15min 15min	100Cycles	22PCS	0/1
High Temperature Storage	Ta=150°C		22PCS	0/1
Low Temperature Storage	Ta=-55°C	500hrs	22PCS	0/1
Temperature and Humidity Test	Ta=85°C RH=85%	500hrs		0/1
Soldering Test	Ta=245°C T=5 sec	1 time	5PCS	